

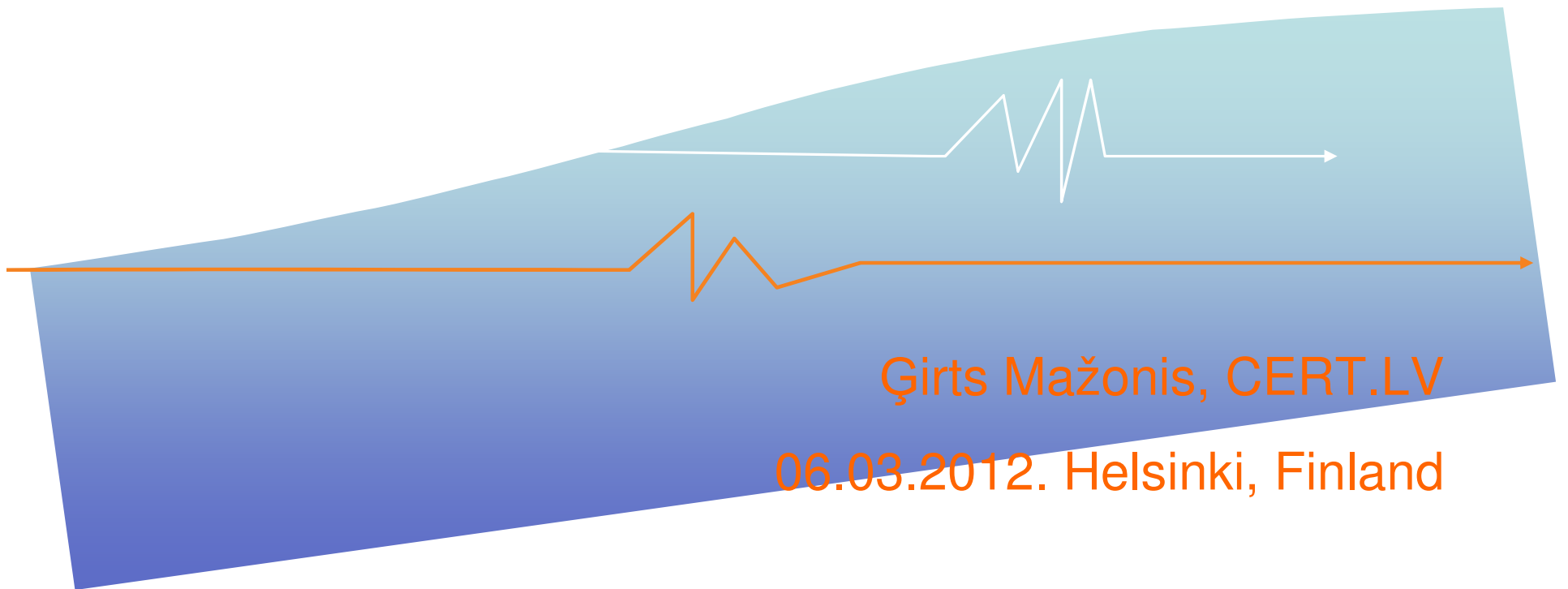

***CERT.LV:***

# ***AbuseHelper Implementation***



Ģirts Mažonis, CERT.LV

06.03.2012. Helsinki, Finland

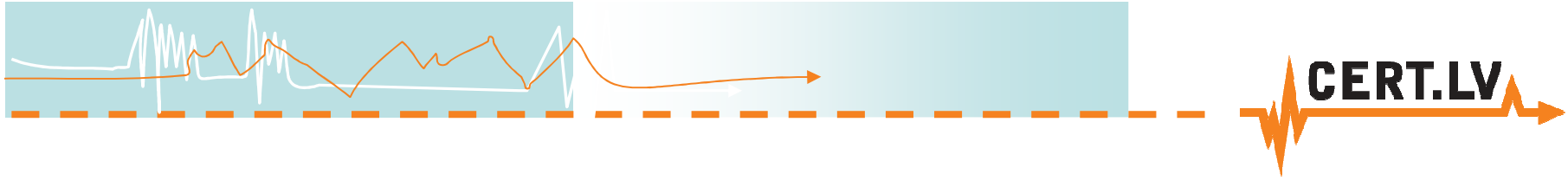

# Installation

- Added Bots
- Import/Export possibilities
- Recommendation



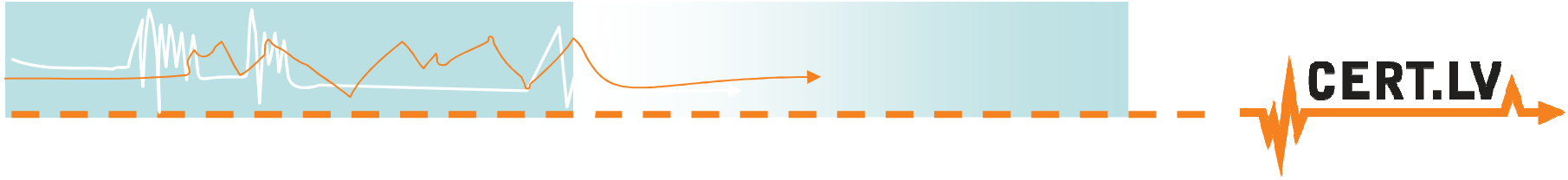

## Used Feeds

- Shadowserver
- Clean-MX
- DShield
- Other feeds (non-AH):
  - Abuse mails
  - Spamcop
  - Fastflux



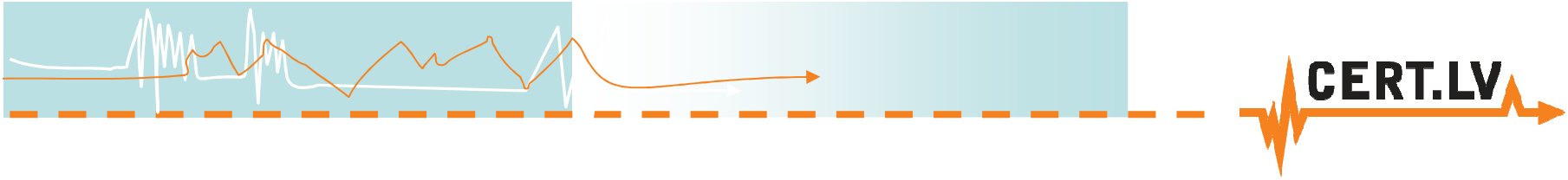

# Usage

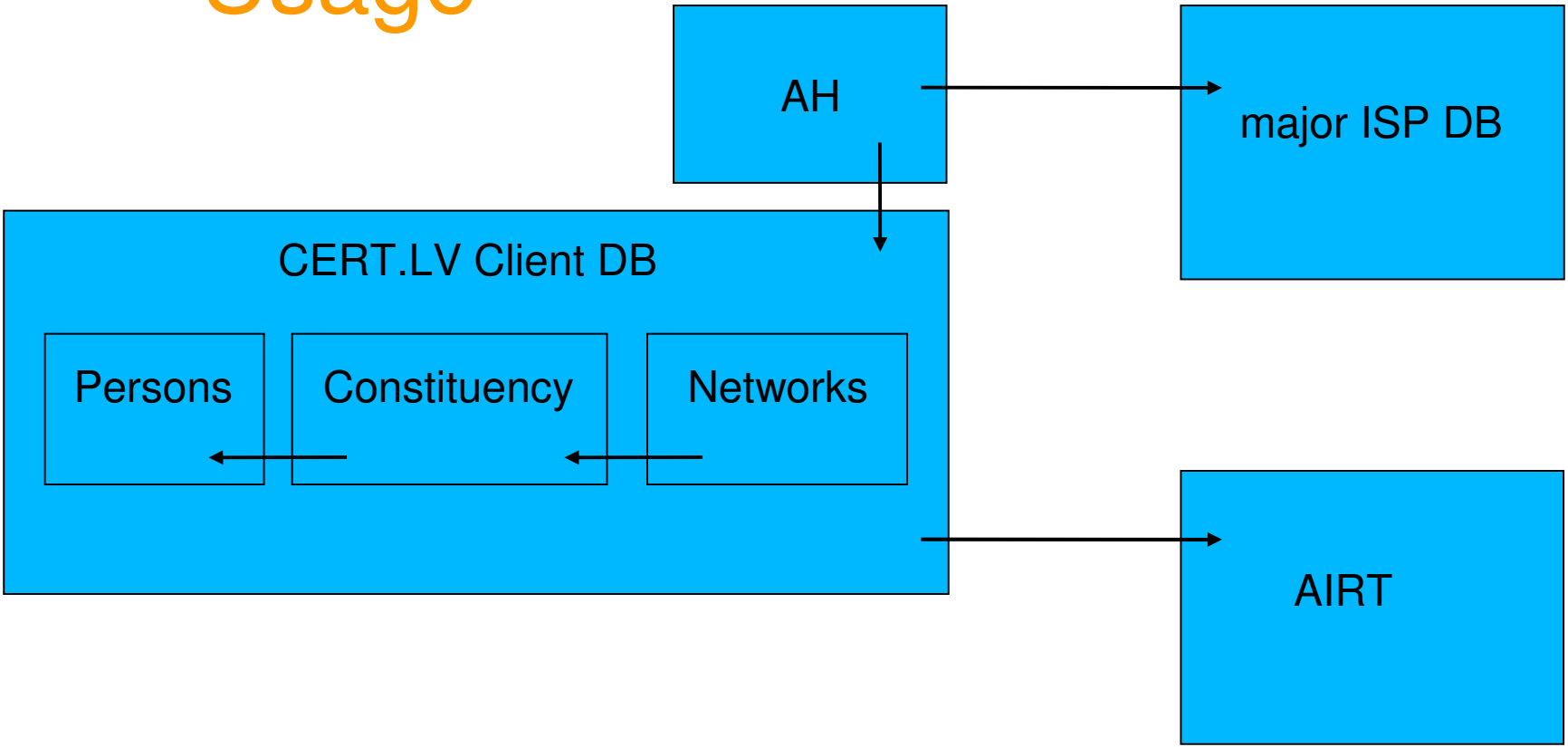

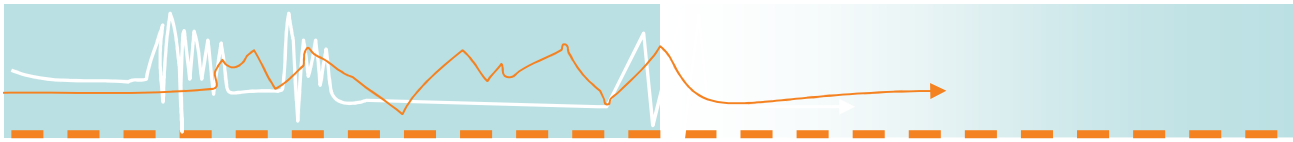

# Statistics

CERT.LV reģistrētie incidenti pa tiem

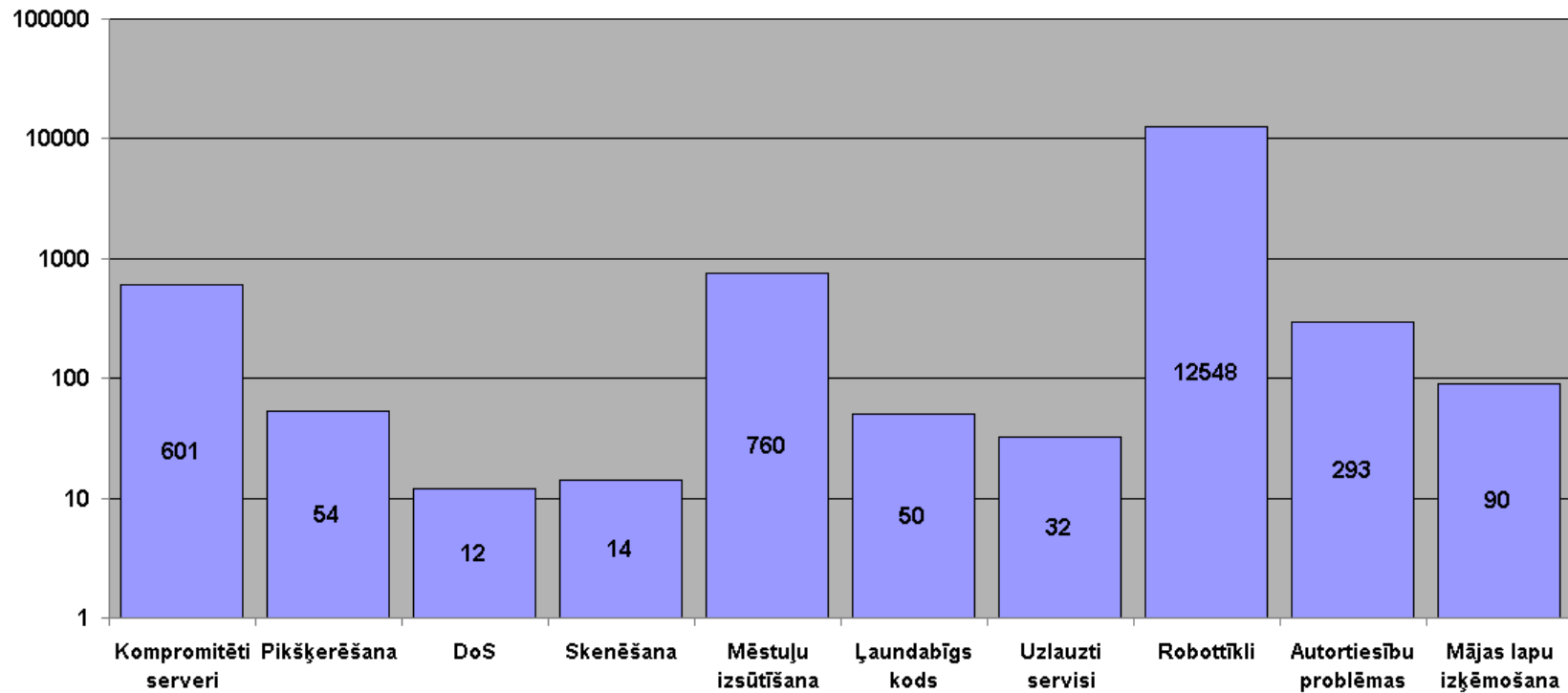

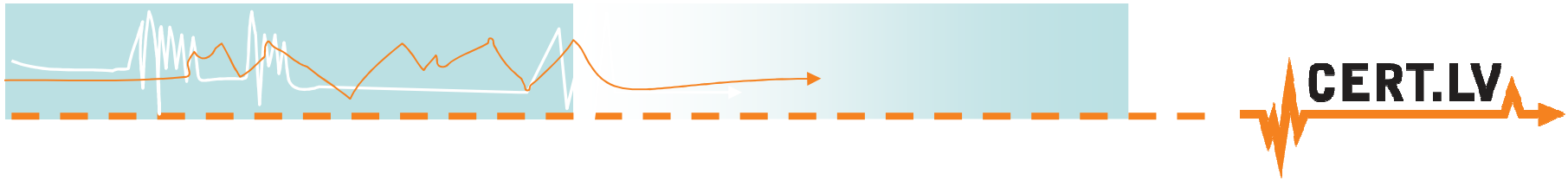

**Thank you!!!**

**<http://ww.cert.lv/>  
cert@cert.lv  
girls.mazonis@cert.lv**

